

Life Is On

Schneider
Electric

Galaxy VX

Highly efficient, scalable, three-phase power protection with flexible operating modes for large facilities, data centers, and business-critical applications.



1000kW Expandable,
1250kW, 1500kW; 400V

[schneider-electric.com](https://www.schneider-electric.com)

Galaxy VX — Scalable, flexible power protection that meets your business objectives.

Highly efficient, scalable, three-phase power protection from 1000 KW to 1500 KW, with flexible operating modes, for large facilities, data centers, and industrial applications.

- Flexible operating modes, including ECOConversion™, deliver very high efficiency even at very low load levels
- Four-level inverter technology, increasing UPS reliability and availability
- Flexible energy storage solutions, including support for li-ion batteries
- Fully rated system with KVA=KW at 40 °C
- Modular, scalable, and redundant configurations, to adapt to real facility needs
- Smart Power Test (SPoT) mode, to test the UPS at site before connecting to real load
- Color touch-screen display with a separate mimic diagram



Galaxy VX: Scalable design

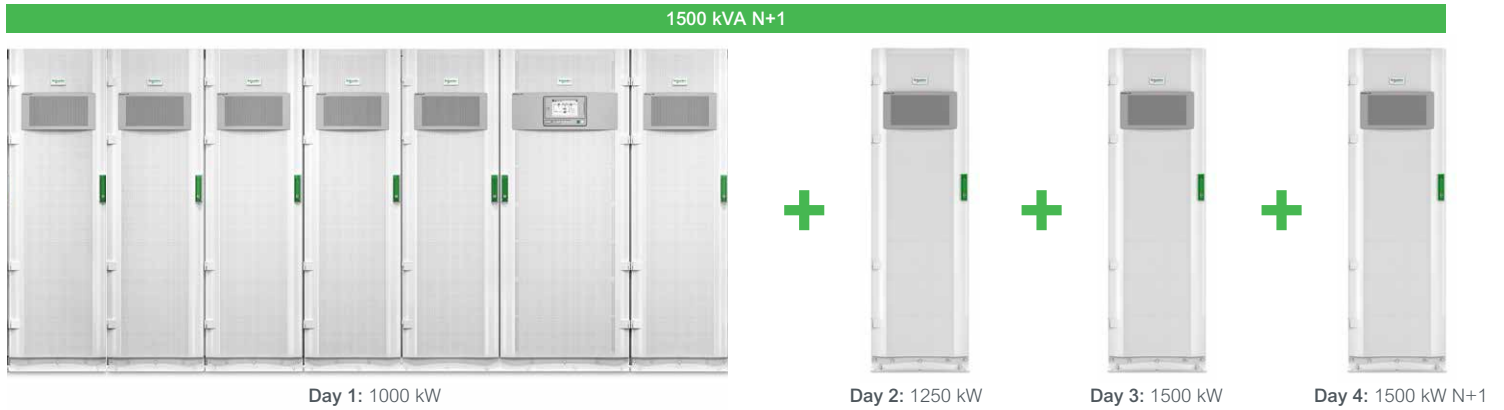

Modular design

The Galaxy™ VX system scales using 250 kW power cabinets. Power cabinets can be added after initial installation to allow for load growth or increased redundancy.

Select your efficiency

Galaxy VX offers three modes of operation. Each mode offers a unique combination of efficiency and performance. Select the mode that best meets your business objectives.

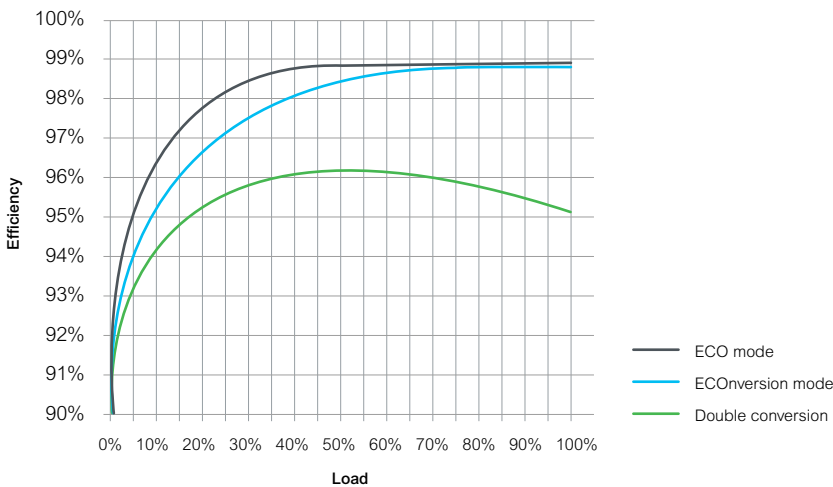

Efficiency curves based on 1000kW, 415V UPS data.

Efficiencies are preliminary until validated efficiency data is available.

Reliable, scalable power protection

Galaxy VX redefines how UPS systems meet business objectives. The Galaxy VX's flexibility provides the perfect platform to grow or renew your mission-critical applications. Innovative technologies allow you to select the best match of UPS performance to your business objectives. It offers an adaptable approach to your changing needs. The system can scale or add redundancy after the initial installation. The Galaxy VX supports a wide range of energy storage options, allowing future technologies to integrate into your existing platform.

Galaxy VX: Preserving capital

Optimize operational expenses

Your business has unique operational goals, and Galaxy VX meets them with three modes of operation. Choose one or a combination of all three to meet your uptime and power consumption goals:

ECONversion mode

- Ultra high efficiency up to 99%
- Keeps excellent load protection
- Continuously charges batteries
- Compliant with IEC 62040-3 Class 1 output voltage of UPS standard
- Input power factor correction and low input harmonics
- No-break transfers

Double conversion mode

- High efficiency in double conversion online mode even at low load levels
- Less energy losses = cost savings
- Less heat dissipation = lower cooling needed, hence cost savings

ECO mode

- Up to 99% efficiency
- Compliant with IEC 62040-3 Class 3 output definition of UPS standard

Manage risk

Stable, protected power is critical to the success of your business. Galaxy VX is designed to meet strict uptime requirements with these design features:

- Innovative four-level inverter reduces losses and component stress, leading to higher efficiency and component reliability
- Configurable internal redundancy provides a fault-tolerant design
- A 110% continuous-duty static switch provides robust overload capabilities
- Modular fault-tolerant power blocks reduce mean time to repair
- SPoT mode allows testing of UPS before connecting to a critical load
- Built-in backfeed protection provides human safety and compliance, and saves installation cost

Preserve capital

Your facility needs to grow with your expanding business. Galaxy VX delivers that flexibility along with innovative, cost-saving solutions at every step of the design, installation, and ownership life cycle:

- Pay as you grow — scale system power as load demands increase by adding 250 kW power cabinets after initial installation
- Scale the system for capacity or redundancy
- Fully rated system with KVA=KW at 40 °C
- The power factor correction and harmonics filtering at input eliminates oversizing of the upstream gears



Galaxy VX: ECOConversion mode

ECOConversion mode

Enables control of input current close to the same quality as the on-line UPS with zero-break transfer in the event of a power outage.

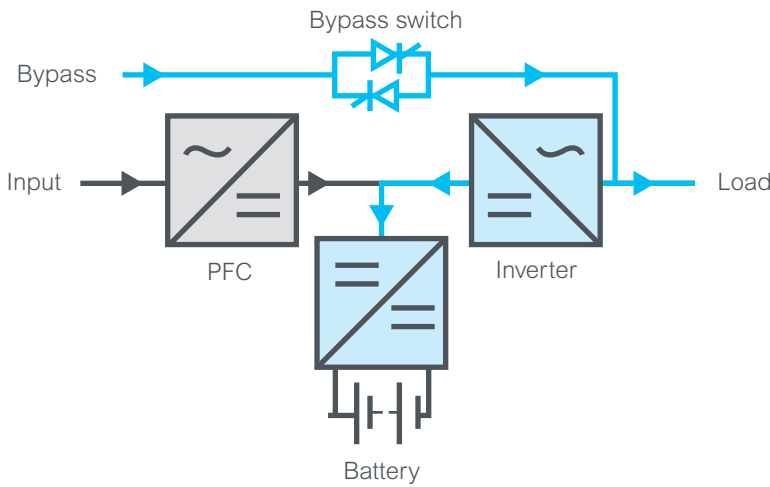

Galaxy VX ECOConversion meets Class 1 of IEC 62040-3: Zero break transfer during power outage

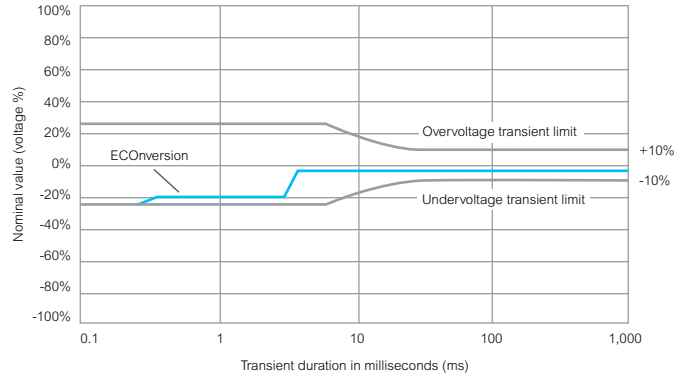

Energy cost savings by using Galaxy VX in ECOConversion Mode

	Galaxy VX with high-efficiency double conversion	Legacy double conversion UPS	Rotary UPS
Efficiency at 75% load	95.8%	94%	93%
Savings by using Galaxy VX/year (in ECOConversion mode)	\$31,500	\$49,600	\$60,800
Ten-year savings by using Galaxy VX (in ECOConversion mode)	\$315,000	\$496,000	\$608,000

Considering a total UPS load of 1500 kW with no redundancy.

Calculations assume electricity cost of \$0.13/kWh.

For detailed UPS efficiency comparison, see the Three Phase UPS Efficiency Calculator on schneider-electric.com.

*All figures are estimates. Individual savings could vary.

Galaxy VX: Facility friendly

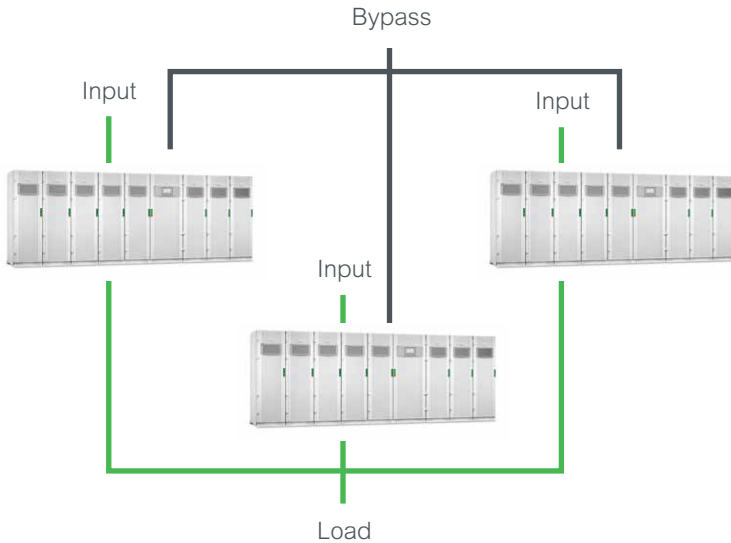

Distributed parallel connection for increased power and redundancy

Integration into your electrical network

- Wide input voltage and frequency ranges
- Genset compliant with adaptive ramp-in
- Integrated parallel capability with N+1 configurations
- Built-in integrated and tested backfeed protection for human safety and compliance
- Provides input power factor correction and harmonics filtering

Integration into your facility infrastructure

- Compact footprint
- Back-to-the-wall installation
- Operates at 40 °C continuously without de-rating
- Embedded seismic certified to IBC2012 and CBC2013 to $S_{ds}=1.84\text{ g}$
- Low audible noise levels
- Replaceable dust filter for harsh environments
- Configurable input/output relays
- Top and bottom cable entry
- Parallel capability to increase multiple UPS systems for capacity (3MW N+0) or redundancy (3MW N+1)
- External synchronization capability to support synchronized 2N configuration

Full integration with Schneider Electric solutions

Fully integrates into the comprehensive Schneider Electric energy management solution for data centers and industrial applications.

Smart power test

Ability to test the UPS at full load without the need to rent a load bank and before bringing critical load online.

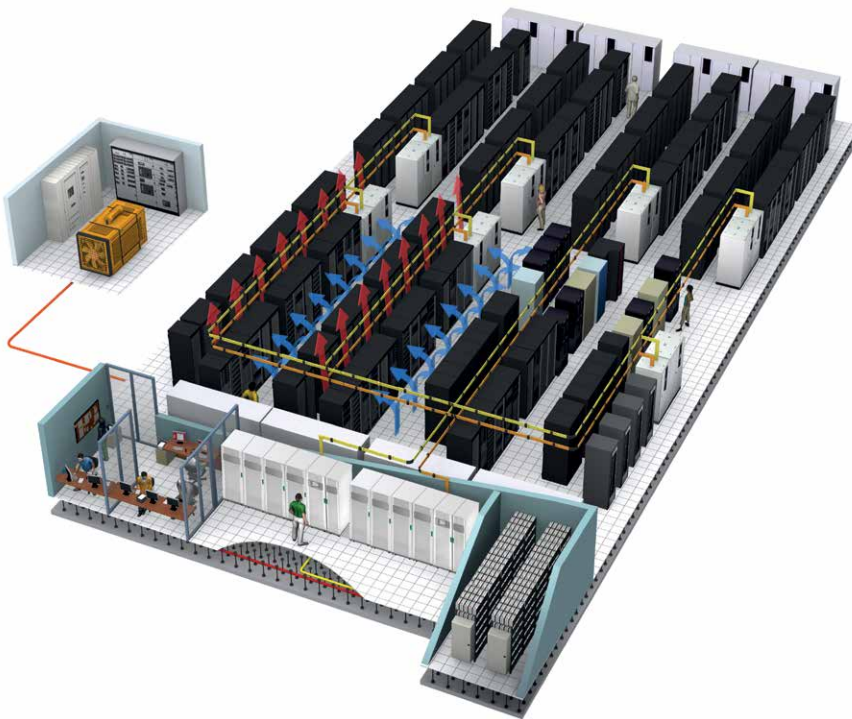

Software and services



Data center infrastructure management software

In the data center environment, Galaxy VX is fully managed through StruxureWare™ for Data Centers software, an integrated suite of data center infrastructure management (DCIM) applications. It enables businesses to prosper by managing their data centers across multiple domains, providing actionable intelligence for an ideal balance of high availability and peak efficiency throughout the entire data center life cycle. StruxureWare software applications are key elements of Schneider Electric EcoStruxure™ integrated hardware and software system architecture — a system designed for intelligent energy management.

StruxureOn

StruxureOn monitors and protects your critical equipment, providing 24/7 visibility through live data, smart alarming, and data-driven insights on the health of your connected assets directly to your smartphone. Regular reports keep you informed of the status of your unit lifespan and when to plan for battery replacement.

In the event of an incident, experts will provide remote troubleshooting or help dispatch an FSE for on-site support.

A comprehensive portfolio of services

Schneider Electric provides the expertise, services, and support you need for your building, industry, power, or data center infrastructure. Our world-class life cycle services offer a smart way to install and maintain your critical applications, ensuring your systems are always running at peak performance.

Assembly and start-up service by a certified Field Service Engineer (FSE) allows full factory warranty coverage. A Schneider Electric-certified installation makes certain your equipment is properly configured for optimal performance. This service features a standard eight-hour, five-day response time, with upgrades available for off-business hours.

On-site warranty extension service

In the case of a system event, an FSE will arrive by the next business day (or faster with upgrades) to isolate, diagnose, and correct in as little time as possible, minimizing downtime.

Advantage plans

Flexible service packages offer smooth system maintenance to improve uptime at a predictable cost. The Advantage Plus, Prime, Ultra, and Max are full-service packages that include technical support, preventive maintenance, quick on-site response, and monitoring. Response time upgrades are available.

Preventive maintenance

Preventive maintenance on-site examinations keep your critical systems running at maximum efficiency.

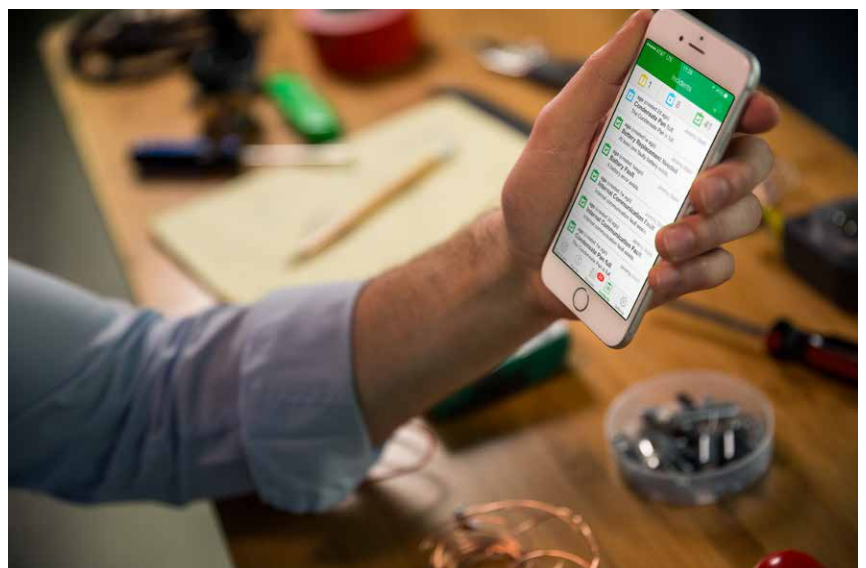

1000/1250/1500 kW UPS

Input parameters			
Rectifier type	IGBT active rectifier		
Input voltage	380 V/400 V/415 V +20% /-15%, 3PH + G		
Input connection	Single or dual feed		
Frequency	50 Hz nominal (40 – 70 Hz)		
Input power factor	>0.99		
THDi	<3% @ 100% load		
Walk in	0 to 40 sec (configurable)		
Output parameters			
Inverter type	4 Level IGBT, high efficiency, transformer-less		
Output voltage	380 V/400 V/415 V 3PH + N + G		
Load power factor	0.7 leading to 0.5 lagging without UPS derating		
Output voltage regulation	+/-1%		
Output frequency regulation	50Hz +/- 0.1%		
Overload in normal operation	150% for 60 sec at 40 °C		
Overload in bypass operation	110% continuous		
Output power factor	1.0 kVA = kW		
Voltage distortion (THD)	<2% at 100% linear load; <3% at 100% nonlinear load		
DC parameters			
Nominal DC bus voltage	480 VDC		
Battery type	VRLA, flooded, li-ion		
Efficiency			
Double conversion mode	Up to 96.1%		
ECO conversion mode	Up to 98.8%		
ECO mode	Up to 98.9%		
Communication			
Control panel	Multifunction touch-screen color LCD display Modbus TCP/IP, SNMP, email, Modbus RS-485 (optional)		
Physical			
1000 kW UPS (H x W x D)	1970 mm x 4400 mm x 900 mm		
1250 kW UPS (H x W x D)	1970 mm x 5000 mm x 900 mm		
1500 kW UPS (H x W x D)	1970 mm x 5600 mm x 900 mm		
Regulatory			
Safety	CE IEC 62040-1	Seismic	IBC2012
EMC/EMI/RFI	IEC 62040-2	Performance	IEC 62040-3 VFI-SS-111
Environmental			
Operating temperature	0 °C – 40 °C	Relative Humidity	0 – 95% noncondensing

Specifications are subject to change without notice. Efficiencies are preliminary until validated efficiency data is available.

132 Fairgrounds Road
West Kingston, RI 02892
USA
Phone: + 800-800-4272
www.schneider-electric.com

Life Is On

